

XLINE
chairs collection
2 0 2 2

INDEX

LEGNO
WOOD

Moderno
Contemporary
03



Tradizionale
Traditional
26



Classico
Classic
34



IMBOTTITI
PADDED

41



METALLO
METAL

49



ALLUMINIO / PLASTICA
ALUMINIUM / PLASTIC

59



FINITURE / FINISHES

81



LEGNO
WOOD

1441

1440

1442

1443

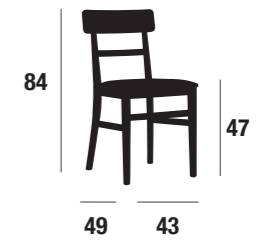
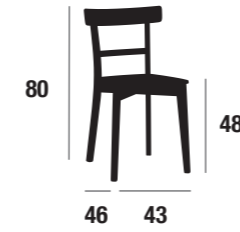
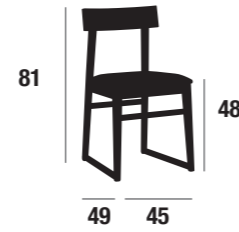
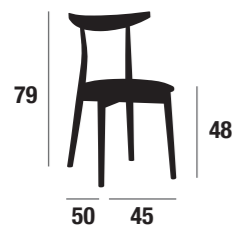

1441 L
 1441 TC
 1441 T1
 1441 T2

1440 TC
 1440 T1
 1440 T2

1442 L
 1442 TC
 1442 T1
 1442 T2

1443 L
 1443 TC
 1443 T1
 1443 T2

1425

1426

1424

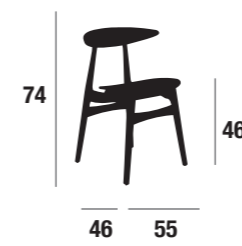
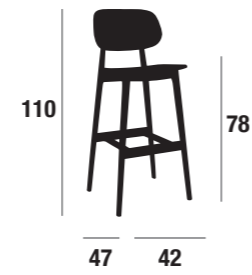

1425 L
 1425 TC
 1425 T1
 1425 T2

1426 L
 1426 TC
 1426 T1
 1426 T2

1424 L
 1424 TC
 1424 T1
 1424 T2

1412

1413

1414

1417

1418

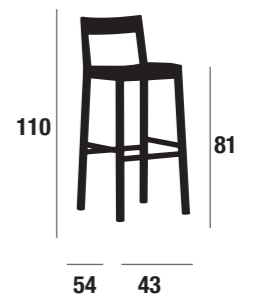
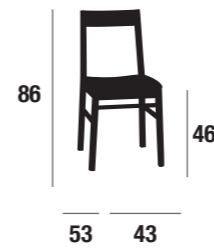
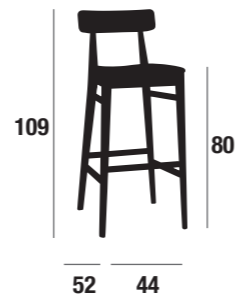
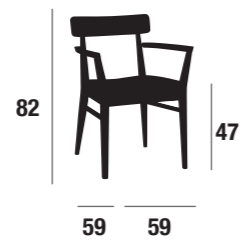
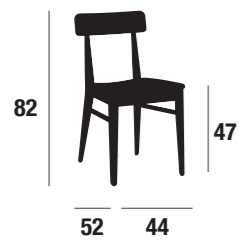

1412 L
1412 TC
1412 T1
1412 T2

1413 L
1413 TC
1413 T1
1413 T2

1414 L
1414 TC
1414 T1
1414 T2

1417 L
1417 TC
1417 T1
1417 T2

1418 L
1418 TC
1418 T1
1418 T2

1433

1434

1435

1436

1437

1438

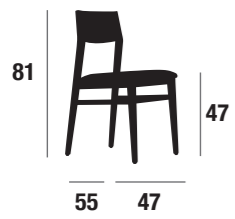

1433 TC
1433 T1
1433 T2

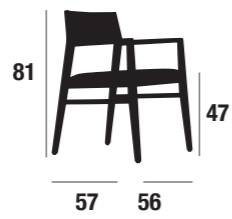

1434 TC
1434 T1
1434 T2

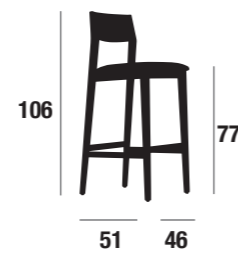

1435 TC
1435 T1
1435 T2

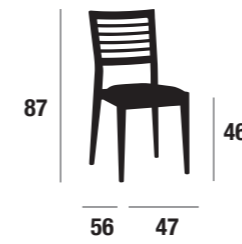

1436 TC
1436 T1
1436 T2

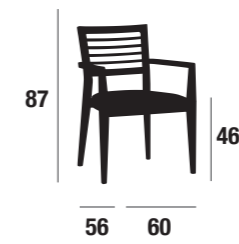

1437 TC
1437 T1
1437 T2

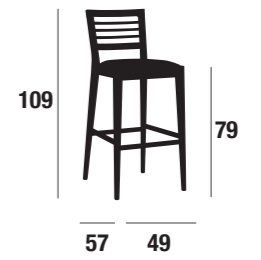

1438 TC
1438 T1
1438 T2

1415

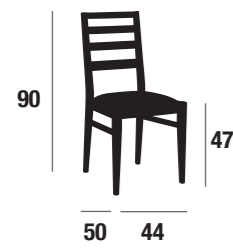

1415 PA
1415 L
1415 TC
1415 T1
1415 T2

1416

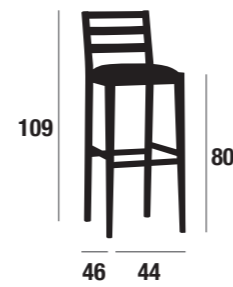

1416 L
1416 TC
1416 T1
1416 T2

1350

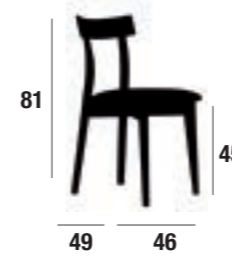

1350 L
1350 TC
1350 T1
1350 T2

1444

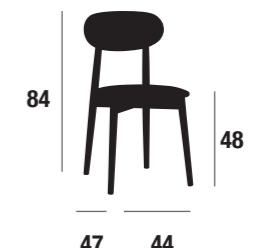

1444 L
1444 TC
1444 T1
1444 T2

1419



1351



1345



1346

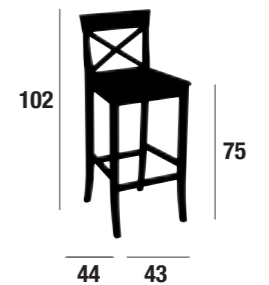
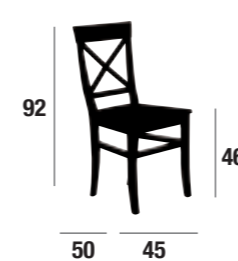
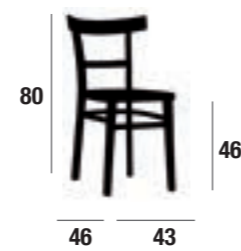
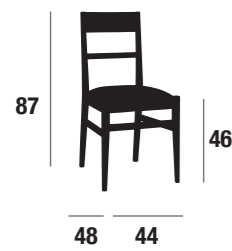

1419 L
1419 TC
1419 T1
1419 T2

1351 L

1345 L
1345 TC
1345 T1
1345 T2

1346 L
1346 TC
1346 T1
1346 T2

1347

1348

1366

1367

1317

1318

1319

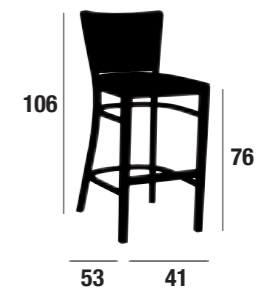
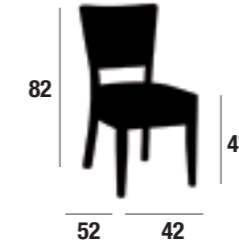
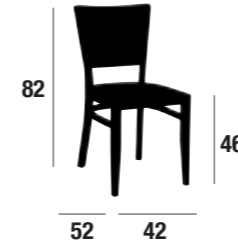
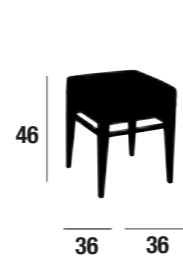
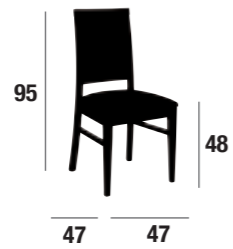
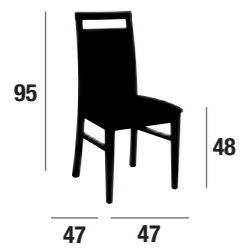

1347 TC
1347 T1
1347 T2

1348 TC
1348 T1
1348 T2

1366 TC
1366 T1
1366 T2

1367 TC
1367 T1
1367 T2

1317 L
1317 TC
1317 T1
1317 T2

1318 TC
1318 T1
1318 T2

1319 L
1319 TC
1319 T1
1319 T2

1447

1448

1449

1445

1446

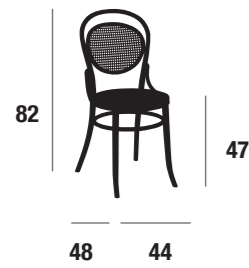

1447 PA
1447 TC
1447 T1
1447 T2

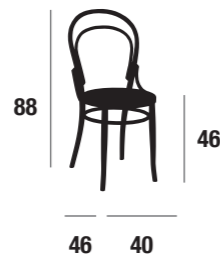

1448 L
1448 TC
1448 T1
1448 T2

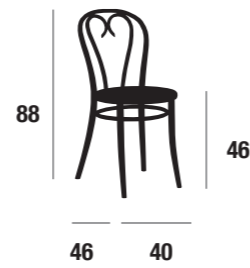

1449 L
1449 TC
1449 T1
1449 T2

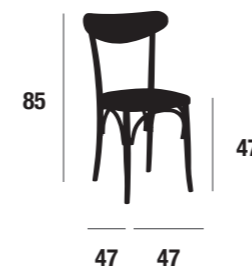

1445 L

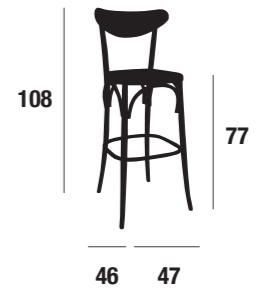

1446 L

1320

1321

1335

1373

1336

1371

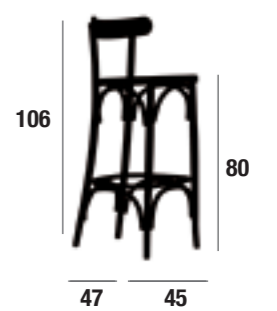
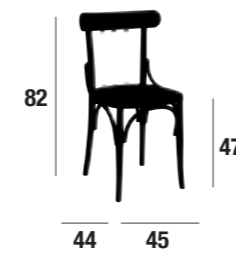
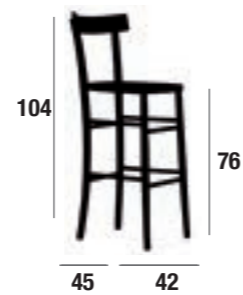
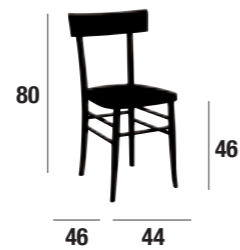
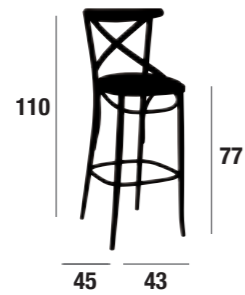
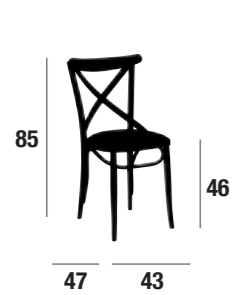

1320 L
1320 TC
1320 T1
1320 T2

1321 L
1321 TC
1321 T1
1321 T2

1335 L

1373 L

1336 L
1336 TC
1336 T1
1336 T2

1371 L
1371 TC
1371 T1
1371 T2

1025

1026

1052

1450

1451

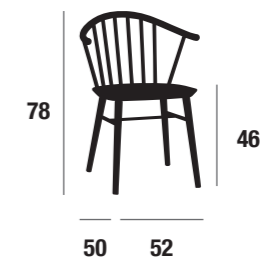
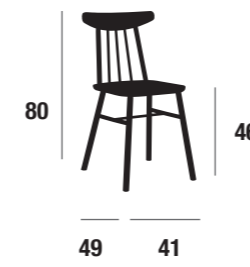
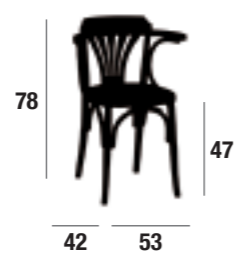
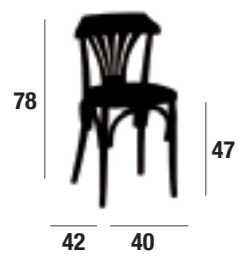

1025 L
1025 TC
1025 T1
1025 T2

1026 L
1026 TC
1026 T1
1026 T2

1052 L
1052 TC
1052 T1
1052 T2

1450 L

1451 L

1375

1408

1376

1452

1453

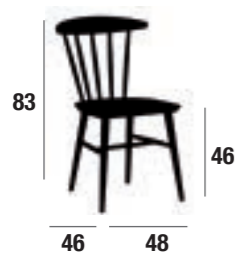

1375 L

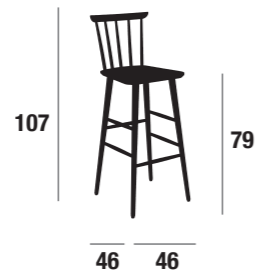

1408 L

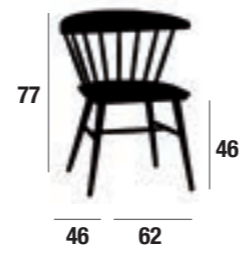

1376 L

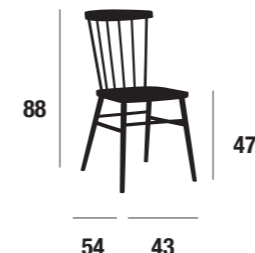

1452 L

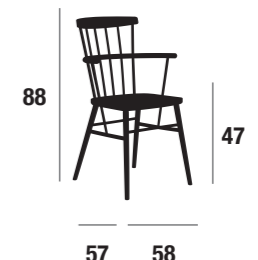

1453 L

1396

1398

1229

1401

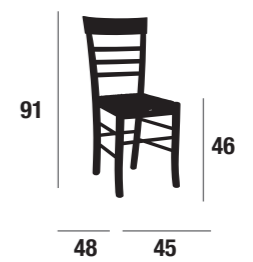
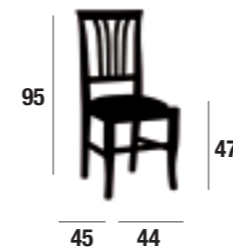
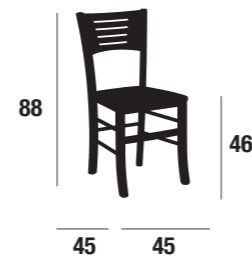
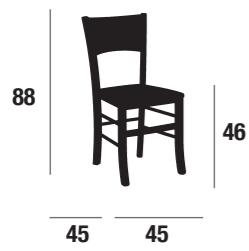

- 1396 PA
- 1396 L
- 1396 TC
- 1396 T1
- 1396 T2

- 1398 PA
- 1398 L
- 1398 TC
- 1398 T1
- 1398 T2

- 1229 PA
- 1229 L
- 1229 TC
- 1229 T1
- 1229 T2

- 1401 PA
- 1401 TC
- 1401 T1
- 1401 T2

1007

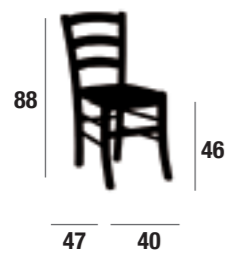

1007 PA
1007 L
1007 TC
1007 T1
1007 T2

1454

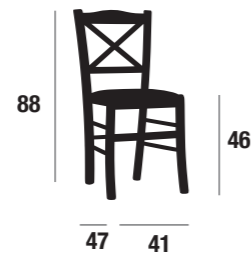

1454 PA
1454 L
1454 TC
1454 T1
1454 T2

1073

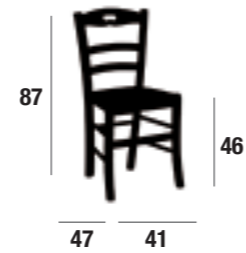

1073 PA
1073 L
1073 TC
1073 T1
1073 T2

1060

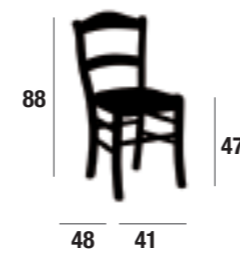

1060 PA
1060 L
1060 TC
1060 T1
1060 T2



1455

1121

1126

1157

1104

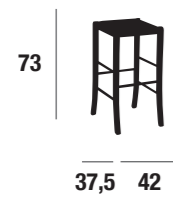

1455 PA



1121 L

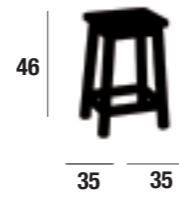

1126 L



1122 L



1127 L

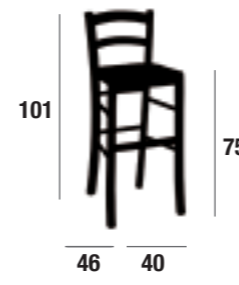

1157 PA
1157 L

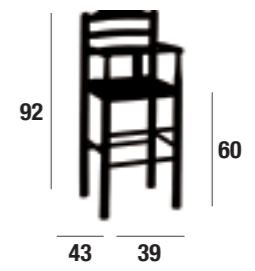

1104 PA
1104 TC
1104 T1
1104 T2

1152-1153-1154

1153



1153/B

1152

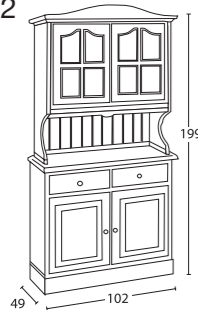

1153

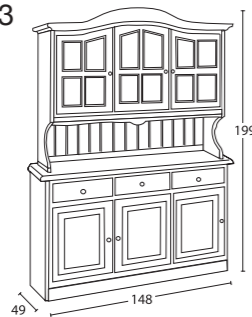

1152/B

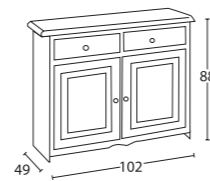

1153/B

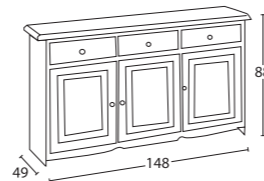

1154

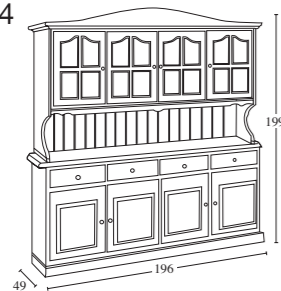

1154/B

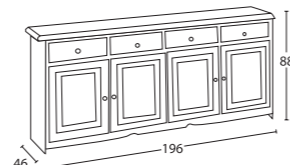

1144

1145

1146

- 1144 GP
- 1144 GP1
- 1144 GP2
- 1144 GP3

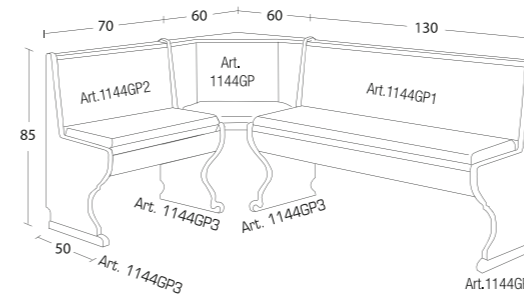

Su misura a richiesta.
Made to measure on request



1146
130/150

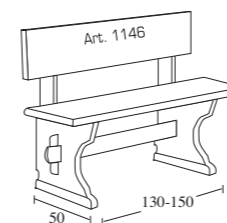

1145
130/150
70/80

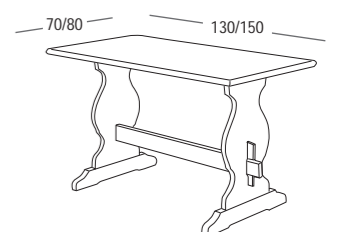

4210

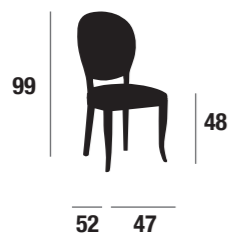

4210 TC
4210 T1
4210 T2

4211

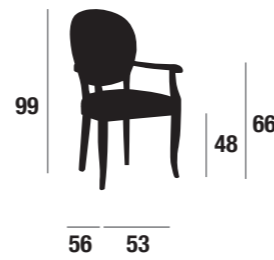

4211 TC
4211 T1
4211 T2

4212

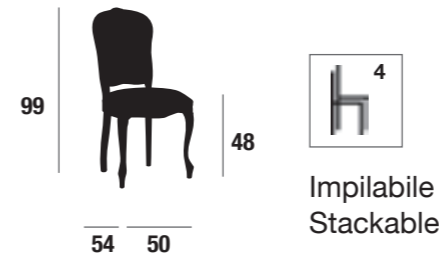

4212 TC
4212 T1
4212 T2

4213

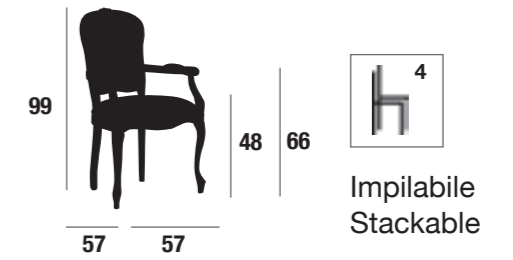

4213 TC
4213 T1
4213 T2

4148



4149



4150



4151



4152

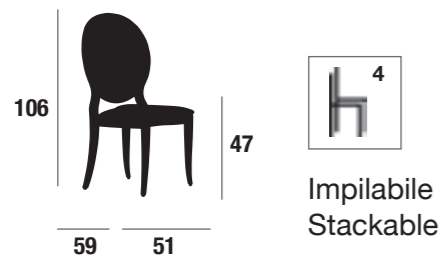

4148 TC
4148 T1
4148 T2

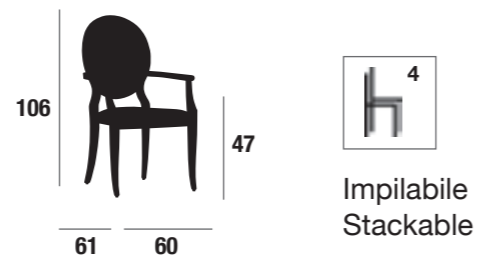

4149 TC
4149 T1
4149 T2

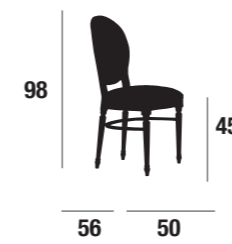

4150 TC
4150 T1
4150 T2

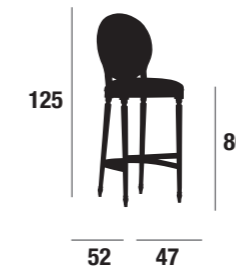

4151 TC
4151 T1
4151 T2

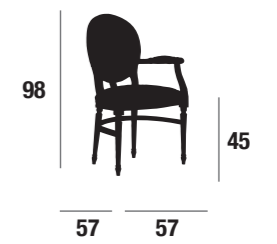

4152 TC
4152 T1
4152 T2

4214

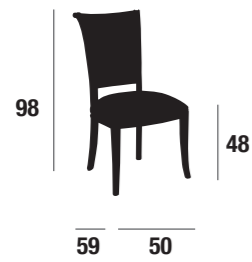

4214 TC
4214 T1
4214 T2

4215

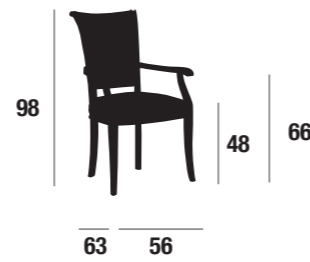

4215 TC
4215 T1
4215 T2

4157

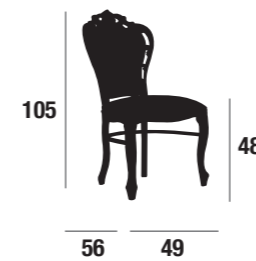

4157 TC
4157 T1
4157 T2

4158

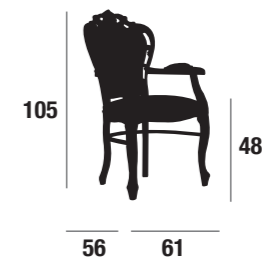

4158 TC
4158 T1
4158 T2

IMBOTTITI
PADDED

4187

4189

4188

4190

4191



SU RICHIESTA
PUNTALI IN OTTONE

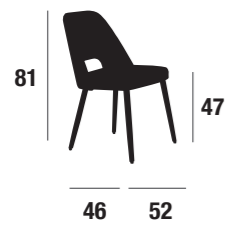

4187 TC
4187 T1
4187 T2

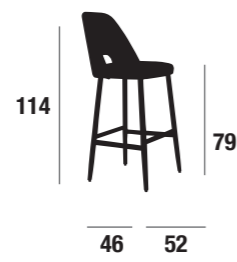

4189 TC
4189 T1
4189 T2

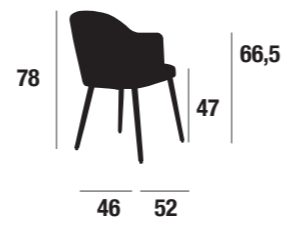

4188 TC
4188 T1
4188 T2

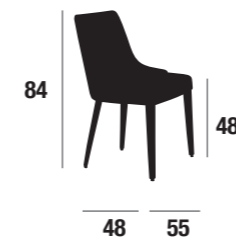

4190 TC
4190 T1
4190 T2

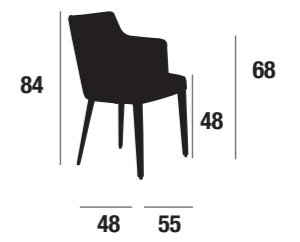

4191 TC
4191 T1
4191 T2

4186



4192



1369



1370



SU RICHIESTA
PUNTALI IN OTTONE

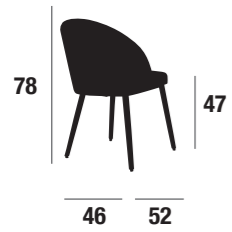

4186 TC
4186 T1
4186 T2

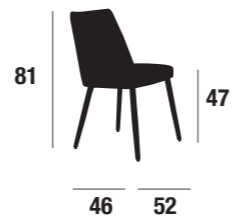

4192 T1
4192 T2
4192 TC

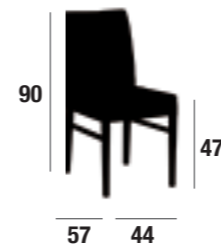

1369 TC
1369 T1
1369 T2

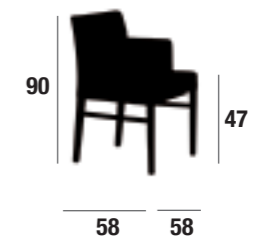

1370 TC
1370 T1
1370 T2

4136L

1310

1349

4131

4132

4133

4134

4082

4081

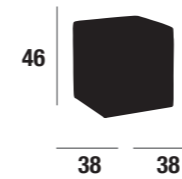

4131 TC
4131 T1
4131 T2
con piedini
with feet

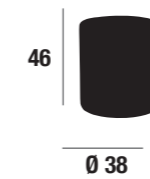

4132 TC
4132 T1
4132 T2
con piedini
with feet

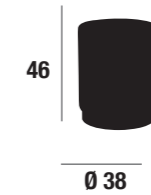

4082 TC
4082 T1
4082 T2
con zoccolo
with baseboard

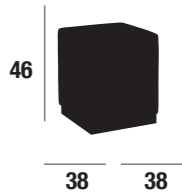

4081 TC
4081 T1
4081 T2
con zoccolo
with baseboard

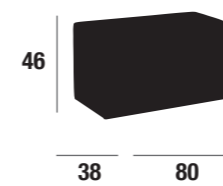

4133 TC
4133 T1
4133 T2
con piedini
with feet

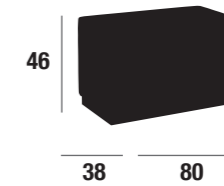

4134 TC
4134 T1
4134 T2
con zoccolo
with baseboard

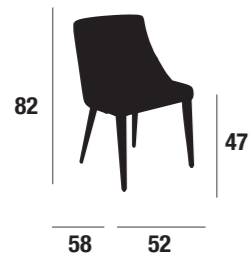

4136L TC
4136L T1
4136L T2

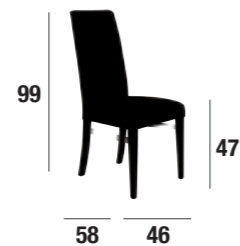

1310 TC
1310 T1
1310 T2



1349 TC
1349 T1
1349 T2

METALLO
METAL

4201

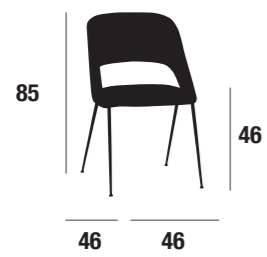

4201 TC
4201 T1
4201 T2

4202

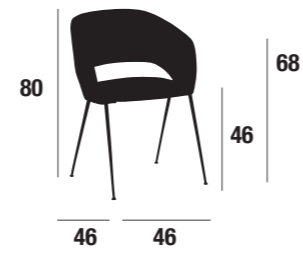

4202 TC
4202 T1
4202 T2

4203

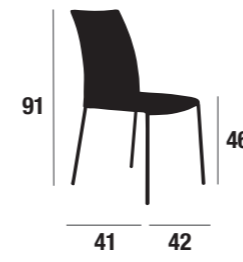

4203 TC
4203 T1
4203 T2

4204

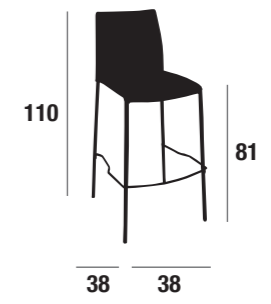

4204 TC
4204 T1
4204 T2

4205

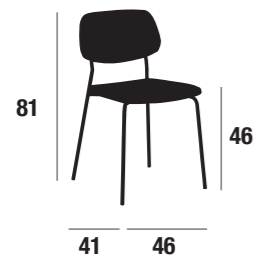

4205 TC
4205 T1
4205 T2

4206



4206 TC
4206 T1
4206 T2

4025



4025 L
4025 TC
4025 T1
4025 T2



Impilabile
Stackable

4102



4102 TC
4102 T1
4102 T2

4101



4101 TC
4101 T1
4101 T2

4031

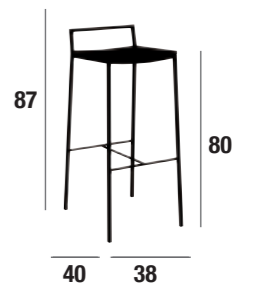

4031 L
4031 TC
4031 T1
4031 T2

4120

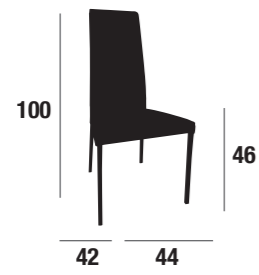

4120 TC
4120 T1
4120 T2

4119

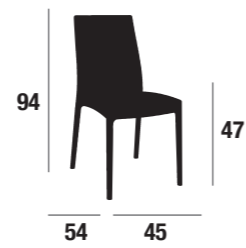

4119 TC
4119 T1
4119 T2

4182

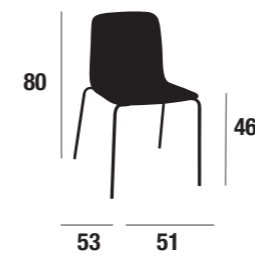

4182 TC
4182 T1
4182 T2

4181

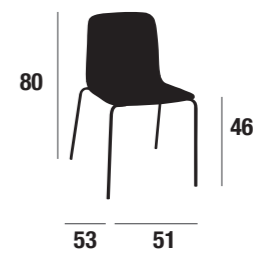

4181 L

4041

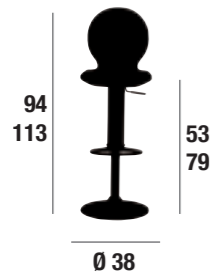

4041

4033

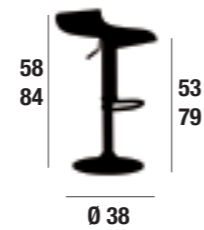

4033

4032

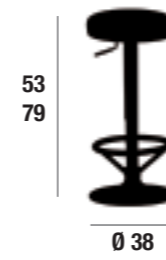

4032 TC
4032 T1
4032 T2

4088

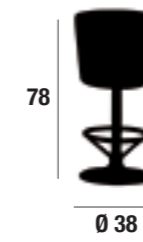

4088 TC
4088 T1
4088 T2

4089

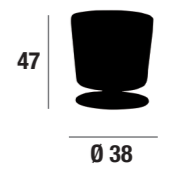

4089 TC
4089 T1
4089 T2

ALLUMINIO/PLASTICA
ALUMINIUM/PLASTIC

3329



Adatto all'uso in ambiente esterno
Suitable for outdoor use

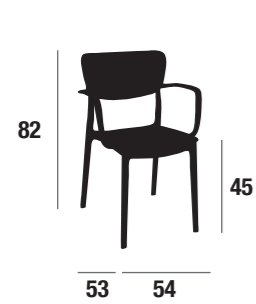

3329/1 3329/13

Altri colori su richiesta
Other colors on request

3331



Adatto all'uso in ambiente esterno
Suitable for outdoor use

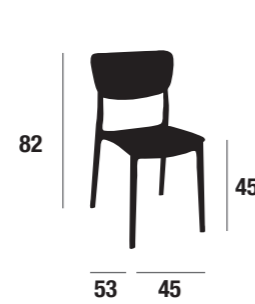

3331/1 3331/13

Altri colori su richiesta
Other colors on request

3336



Adatto all'uso in ambiente esterno
Suitable for outdoor use

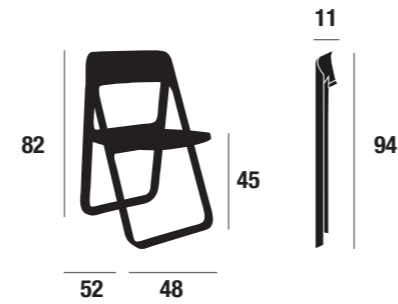

3336/1 3336/2

Altri colori su richiesta
Other colors on request

3332



Adatto all'uso in ambiente esterno
Suitable for outdoor use

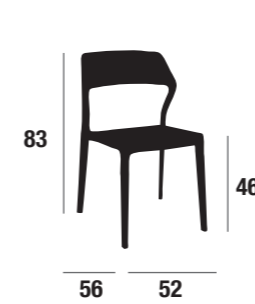

3332/1 3332/2 3332/16

Altri colori su richiesta
Other colors on request

3334



Adatto all'uso in ambiente esterno
Suitable for outdoor use

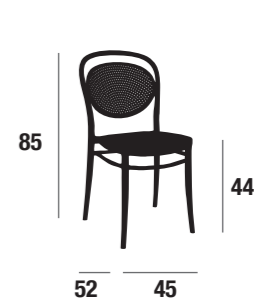

3334/5 3334/13

Altri colori su richiesta
Other colors on request

3337



Adatto all'uso in ambiente esterno
Suitable for outdoor use

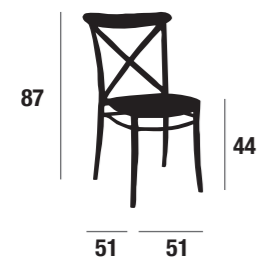

3337/2 3337/5

Altri colori su richiesta
Other colors on request

3335



Adatto all'uso in ambiente esterno
Suitable for outdoor use

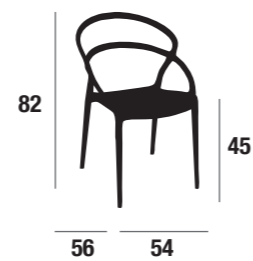

3335/1 3335/2

Altri colori su richiesta
Other colors on request

3310



Adatto all'uso in ambiente esterno
Suitable for outdoor use

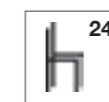
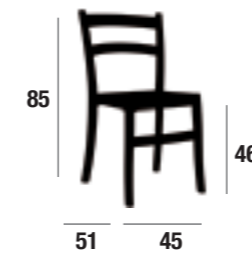

Impilabile
Stackable



3310/2 3310/10 3310/1

Altri colori su richiesta
Other colors on request

3063



Adatto all'uso in ambiente esterno
Suitable for outdoor use

3098



Adatto all'uso in ambiente esterno
Suitable for outdoor use

4092



Adatto all'uso in ambiente esterno
Suitable for outdoor use

4093



Adatto all'uso in ambiente esterno
Suitable for outdoor use

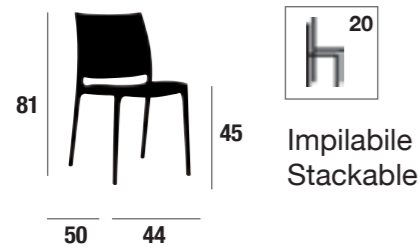

Impilabile
Stackable

50 44



3063/2

3063/5

Altri colori su richiesta
Other colors on request

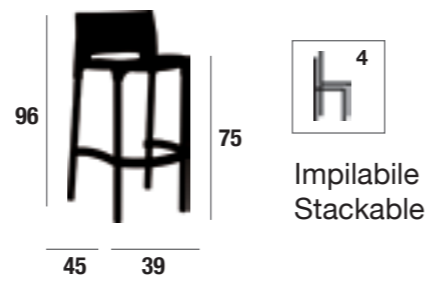

Impilabile
Stackable

45 39



3098/1

3098/2

Altri colori su richiesta
Other colors on request

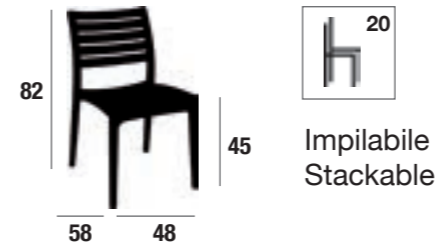

Impilabile
Stackable

58 48



4092/12

4092/13

Altri colori su richiesta
Other colors on request

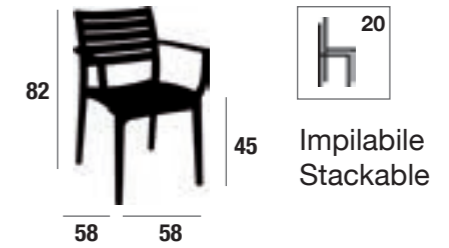

Impilabile
Stackable

58 58



4093/12

4093/13

Altri colori su richiesta
Other colors on request

4170



Adatto all'uso in ambiente esterno
Suitable for outdoor use

4172

4104

4062

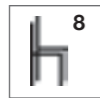
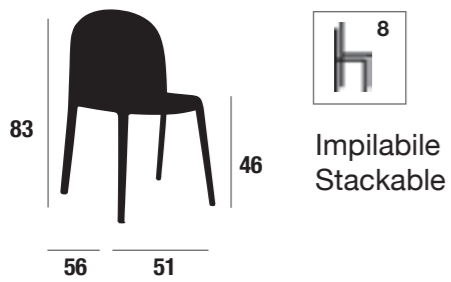

Impilabile
Stackable



4170/2

4170/9

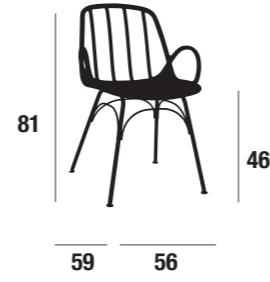

4172/4

4172/9

Struttura in metallo disponibile anche in altri colori / Metal frame in other colors also available
Struttura in metallo verniciata per esterni su richiesta (con sovrapprezzo) / Metal frame painted for outdoor on request (with extra charge)

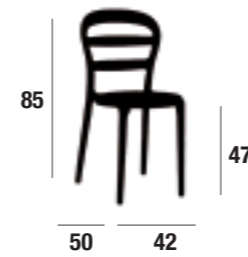

4104

4104/1

Altri colori su richiesta
Other colors on request

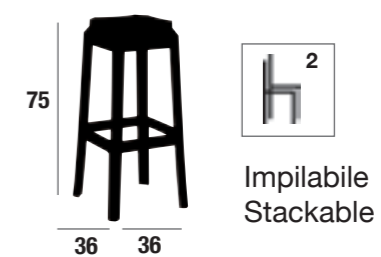

Impilabile
Stackable



4062/1

4062

Altri colori su richiesta
Other colors on request

3315



Adatto all'uso in ambiente esterno
Suitable for outdoor use



3099



Adatto all'uso in ambiente esterno
Suitable for outdoor use



3316



Adatto all'uso in ambiente esterno
Suitable for outdoor use



3318



Adatto all'uso in ambiente esterno
Suitable for outdoor use

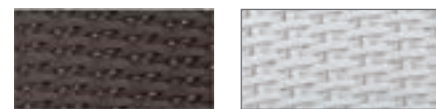
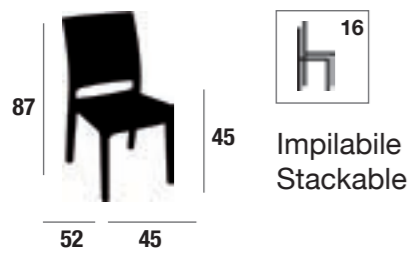

3315 3315/2

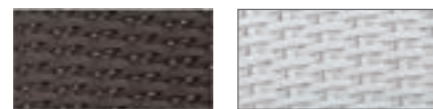
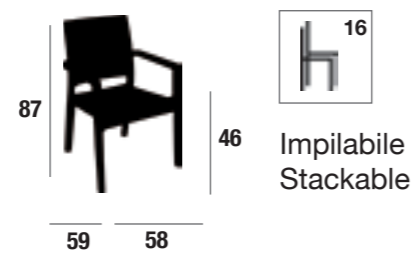

3099 3099/2

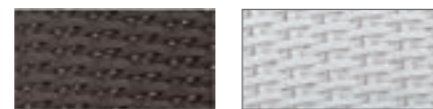
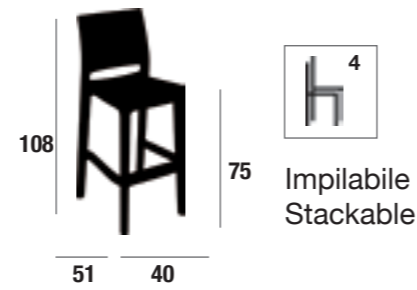

3316 3316/2



3318
80X80 H75



3318/2
80X80 H75

Tavolo rettangolare da cm 140x80 disponibile a richiesta
Rectangular table cm 140x80 available on request

3028



Adatto all'uso in ambiente esterno
Suitable for outdoor use



Cuscino sfoderabile disponibile su richiesta CA1-CA1/2 / I
Removable seat cushion available on demand CA1-CA1/2

3038



Adatto all'uso in ambiente esterno
Suitable for outdoor use



3054



Adatto all'uso in ambiente esterno
Suitable for outdoor use



3052



Adatto all'uso in ambiente esterno
Suitable for outdoor use



3053



Adatto all'uso in ambiente esterno
Suitable for outdoor use



3048



Adatto all'uso in ambiente esterno
Suitable for outdoor use



3049



Adatto all'uso in ambiente esterno
Suitable for outdoor use

3050



Adatto all'uso in ambiente esterno
Suitable for outdoor use

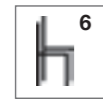
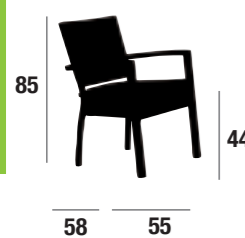

Impilabile
Stackable



50X80 H46

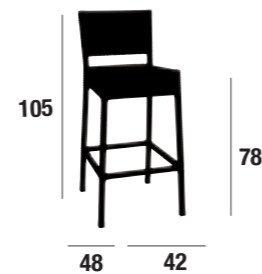

3054

3054/2



3052
H71
PIANO/TOP
Ø90
60x60-70x70-
80x80



3052/2
H71
PIANO/TOP
Ø90
60x60-70x70-
80x80



3053
H71
PIANO/TOP
60x110-70x110-
80x120



3048
Ø55 H71
PIANO/TOP
Ø60 - Ø70



3049
50X50 H71
PIANO/TOP
70x70 - 80x80



3050
96X50 H71
PIANO/TOP
120x80-120X70

3028

3028/2

3038

3078



Adatto all'uso in ambiente esterno
Suitable for outdoor use



3076



Adatto all'uso in ambiente esterno
Suitable for outdoor use



3076	3076	3077

3077



Adatto all'uso in ambiente esterno
Suitable for outdoor use

3079



Adatto all'uso in ambiente esterno
Suitable for outdoor use

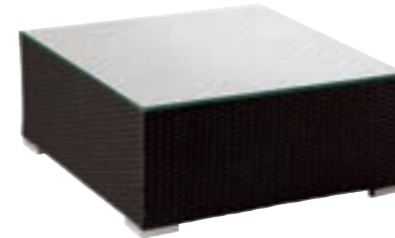

3302



Adatto all'uso in ambiente esterno
Suitable for outdoor use



3071



Adatto all'uso in ambiente esterno
Suitable for outdoor use

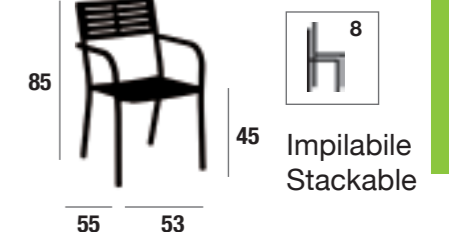
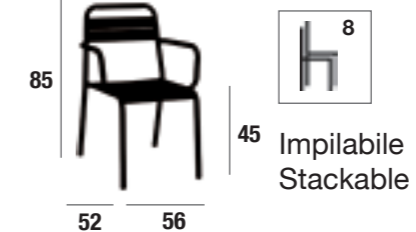
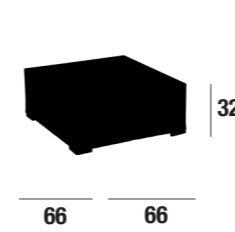
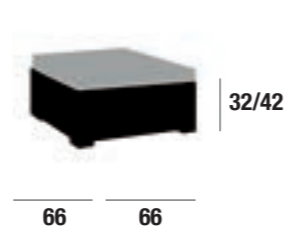
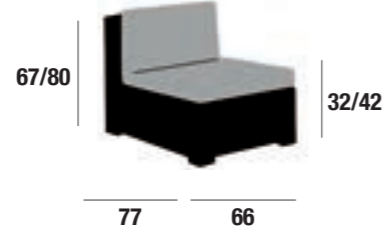
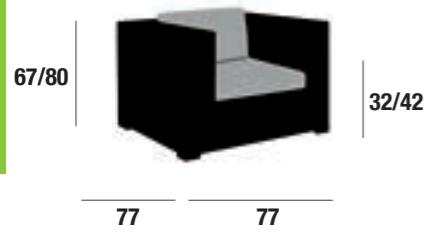

3078 3078/2



3076 3076/2



3077 3077/2



3079 3079/2

3302

3071

4176



Adatto all'uso in ambiente esterno
Suitable for outdoor use



4177



Adatto all'uso in ambiente esterno
Suitable for outdoor use



3045



Adatto all'uso in ambiente esterno
Suitable for outdoor use



3046



Adatto all'uso in ambiente esterno
Suitable for outdoor use



3047



Adatto all'uso in ambiente esterno
Suitable for outdoor use

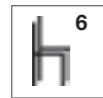
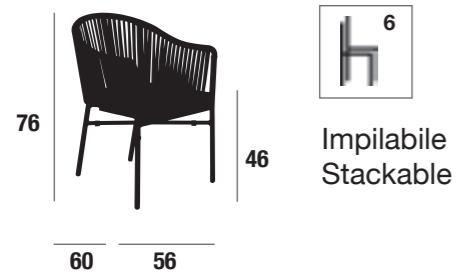

Impilabile
Stackable



4176

4176/2

Cuscino incluso / cushion included

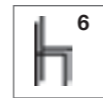
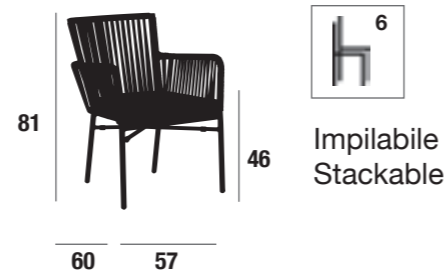

Impilabile
Stackable



4177/2

Cuscino incluso / cushion included



3045
H72
PIANO/TOP
Ø60-Ø70



3046
H72
PIANO/TOP
Ø90
70X70-80X80



3047
H72
PIANO/TOP
60X110-70X110
80X120

3340



Adatto all'uso in ambiente esterno
Suitable for outdoor use

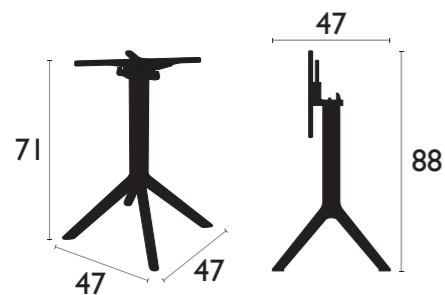

88



3340/1 3340/2

Altri colori su richiesta
Other colors on request

Top min: 50x50 cm, Top max: 70x70 cm

3341



Adatto all'uso in ambiente esterno
Suitable for outdoor use

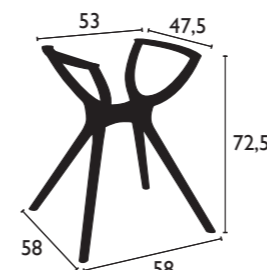

3341/1 3341/2

Altri colori su richiesta
Other colors on request

Top min: 70x70 cm, Top max: 90x90 cm

3342



Adatto all'uso in ambiente esterno
Suitable for outdoor use

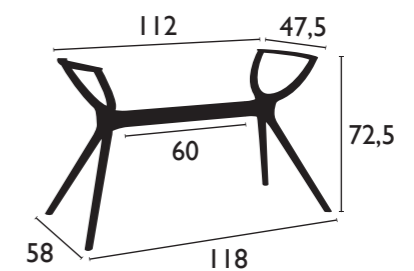

3342/1 3342/2

Altri colori su richiesta
Other colors on request

Top min: 70x120 cm, Top max: 80x160 cm

HPL STRATIFICATO COMPATTO INTERNO SCURO SPESSORE 12MM SOLID HPL LAMINATE DARK CORE THICKNESS 12MM

COLORI DISPONIBILI / AVAILABLE COLORS

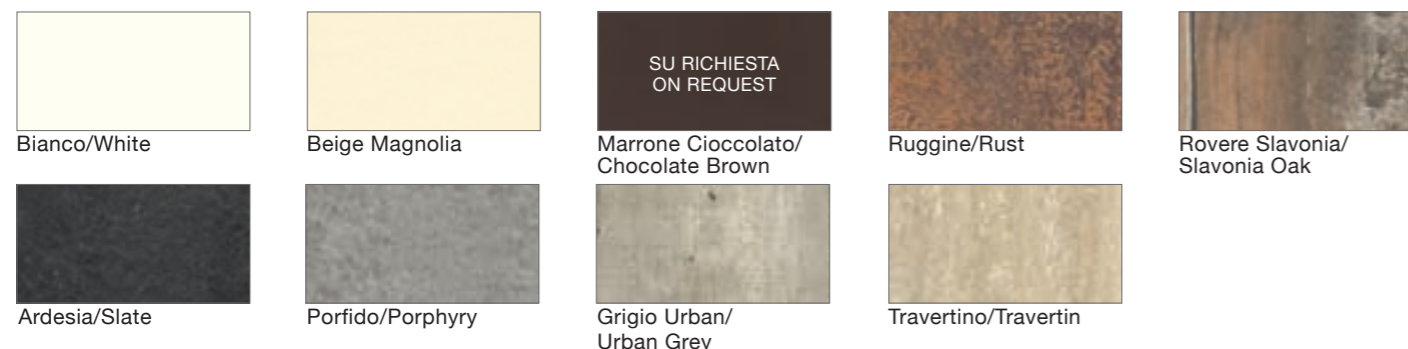

SD 12 - SPESSORE 12MM

Piani in laminato stratificato compatto con interno scuro **spessore 12mm**. I piani sono dotati di bussola di 10 mm di lunghezza.
Solid HPL laminate with dark core, **thickness 12mm**. Tops are equipped with bushes 10 mm length.

12 | Bordo Diritto/Flat Edge

Ø59	59X59	109X59
Ø69	69X69	119X69
Ø79	79X79	



SDI 12 - SPESSORE 12MM

Piani in laminato stratificato compatto con interno scuro **spessore 12mm**. I piani sono dotati di bussola di 10 mm di lunghezza.
Solid HPL laminate with dark core, **thickness 12mm**. Tops are equipped with bushes 10 mm length.

12 | Bordo Inclinato/Slanted Edge

Ø59	59X59	109X59
Ø69	69X69	119X69
Ø79	79X79	

Sulla base dei test effettuati i piani in laminato stratificato HPL con spessore mm 12 garantiscono una solidità maggiore rispetto a quelli di spessore inferiore. La bussola (L. 10 mm – Ø4ma) facilita il montaggio e assicura una perfetta tenuta del piano, specie quando il tavolo viene movimentato frequentemente.

Altre misure su richiesta/Other sizes on request

HPL STRATIFICATO COMPATTO INTERNO IN TINTA SPESSORE 12MM SOLID HPL LAMINATE MATCHING CORE THICKNESS 12MM

COLORI DISPONIBILI / AVAILABLE COLORS

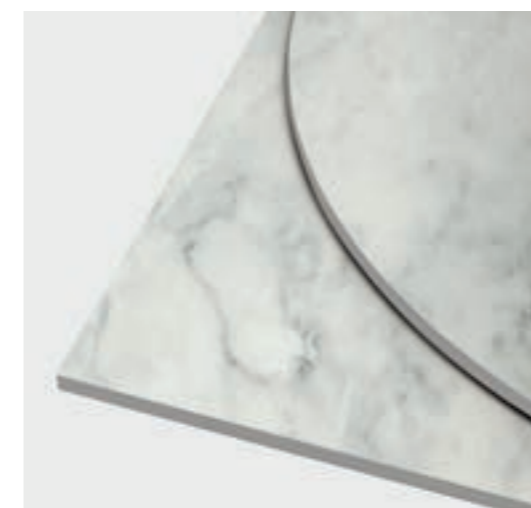

SC 12 - SPESSORE 12MM

Piani in laminato stratificato compatto con interno full color **spessore 12mm**. I piani sono dotati di bussola di 10 mm di lunghezza.
Solid HPL laminate full color core, **thickness 12mm**. Tops are equipped with bushes 10 mm length.

12 | Bordo Diritto/Flat Edge

Ø59	59X59
Ø69	69X69
Ø79	79X79



SCI 12 - SPESSORE 12MM

Piani in laminato stratificato compatto con interno full color **spessore 12mm**. I piani sono dotati di bussola di 10 mm di lunghezza.
Solid HPL laminate full color core, **thickness 12mm**. Tops are equipped with bushes 10 mm length.

12 | Bordo Inclinato/Slanted Edge

Ø59	59X59
Ø69	69X69
Ø79	79X79

According to test we carried out, the HPL laminate tops of 12 mm thickness guarantee a higher strength if compared with thinner HPL tops. The bush (L. 10 mm – Ø4ma) facilitate the montage and ensure a perfect mechanical seal of the top, especially when the table is often displaced

Altre misure su richiesta/Other sizes on request

FINITURE
FINISHES

FINITURE LEGNO / WOOD FINISHES

Legno finiture A / Wood finish A



50 Faggio tinto Noce
Beech-wood stained walnut

Legno finiture B / Wood finish B



51 faggio sbiancato/
white beech



52 faggio naturale/
natural beech



53 faggio tinto rovere/
Beech stained oak



57 Faggio tinto Noce Scuro/
Beech-wood stained
Noce Scuro



56 Faggio tinto Wengé
Beech-wood stained
Wengé



62 Rovere Naturale/
Natural Oak



63 Rovere Tinto Moka/
Oak Stained Moka



64 Rovere Sbiancato/
White Oak



82 Pino Naturale/
Natural Pinewood



83 Pino Tinto Miele/
Pinewood Stained Honey

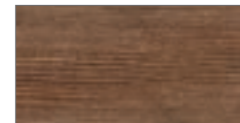

84 Pino Tinto Noce/
Pinewood Stained Walnut



Faggio tinto anilina disponibile
in tutti i colori RAL/
Beechwood stained aniline.
All RAL colors available on
request

Legno finiture C / Wood finish C

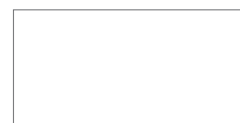

Faggio tinto a campione
Beech-wood stained as
sample



Rovere tinto a campione/
Oak stained as sample



Pino Tinto a campione/
Pinewood Stained as Sample



Laccato disponibile in
tutti i colori RAL/
Lacquered. All RAL
colors available on
request

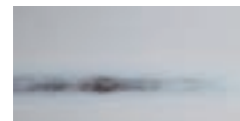

Laccato consumato
su fondo tinto legno
disponibile in tutti i
colori RAL/
Shabby laquered with
woodstain base. All
RAL colors available
on request



Laccato consumato
su fondo colorato
disponibile in tutti i
colori RAL/
Shabby laquered with
painted base. All RAL
colors available on request

Metallo/ Metal



inox lucido/
shiny stainless steel



satinato/brushed



grigio/grey



nero/black

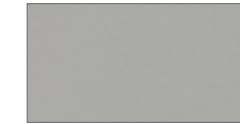

grigio gofrato/
embossed grey



antracite/anthracite



bianco/white



ruggine/rust

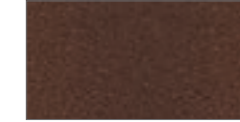

brunito/burnished

Su richiesta sono disponibili altri colori (RAL) / On request other colours (RAL) available

Colori Metallizzati/ Metal Colors



oro/gold



rame/copper

Finiture speciali / Special finishes

A richiesta finiture speciali con sovrapprezzo (disponibili solo su alcuni articoli)
Special finishes available on request with extra charge (for some items only)

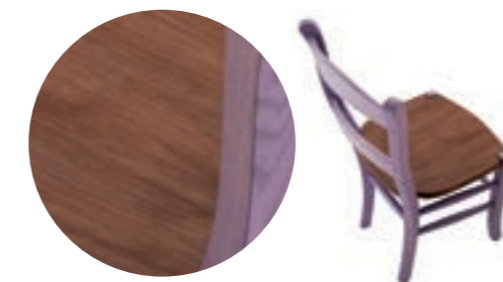

Finitura pennellata tinta all'anilina
Brushed aniline paint



Laccatura bicolore
Two-colors laquered

FINITURE ALLUMINIO / ALUMINIUM FINISHES

Alluminio anodizzato / Anodized aluminium



Alluminio anodizzato/
anodized aluminium

Alluminio verniciato/ Painted aluminium

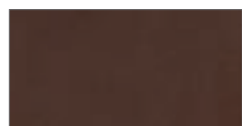

ruggine/rust



crema/cream



nero/black

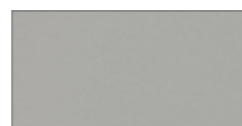

grigio gofrato/
embossed grey



antracite/anthracite

Su richiesta sono disponibili altri colori (RAL) / On request other colours (RAL) available

RIVESTIMENTI / COVERINGS

ECOPELLE / FAUX-LEATHER



T1/309



T1/388



T1/310



T1/367

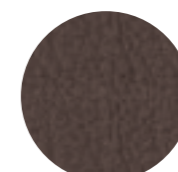

T1/389

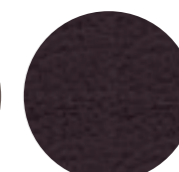

T1/366



T1/393

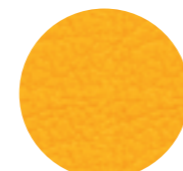

T1/387



T1/392

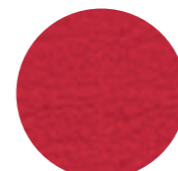

T1/381

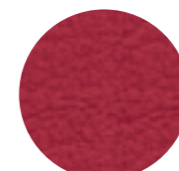

T1/317

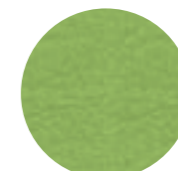

T1/384

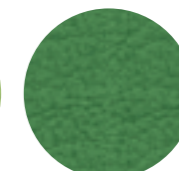

T1/385

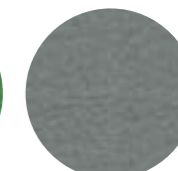

T1/391

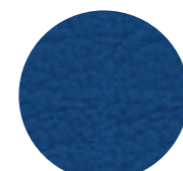

T1/386

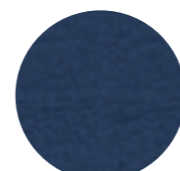

T1/319



T1/379



T1/365

Ingnifugo / Fire Retardant

- Classe 1M (CSE RF 4/83) in accoppiamento con schiuma poliuretanic autoestinguente
- DIN 75200 Germany Automotive Standard
- ISO 3795

TESSUTO LAVABILE / WASHABLE FABRIC



T1/001



T1/002

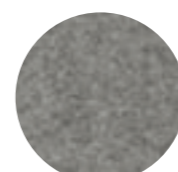

T1/003

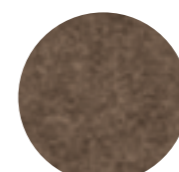

T1/004

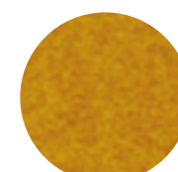

T1/005

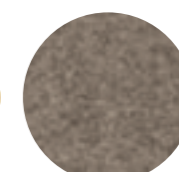

T1/006



T1/007

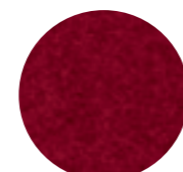

T1/008

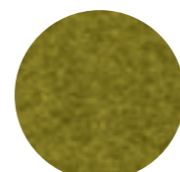

T1/009

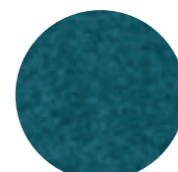

T1/010

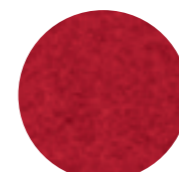

T1/011



T1/012

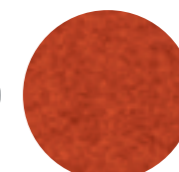

T1/013

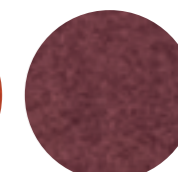

T1/015

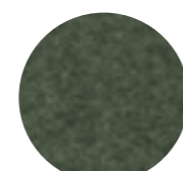

T1/016

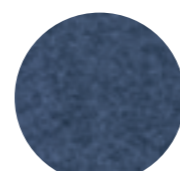

T1/017

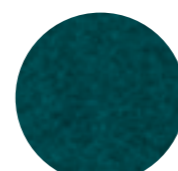

T1/018

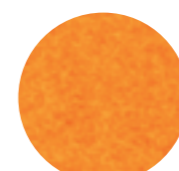

T1/019

Tessuto trattato con una tecnologia rivoluzionaria che permette di togliere la maggior parte delle macchie (vino, inchiostro, sugo, grasso, fango, cioccolato, crema etc.) usando semplicemente un po' d'acqua.

Fabric treated with a revolutionary technology that allows to clean the majority of the stains (wine, ink, sauce, fat, mud, chocolate, cream etc.) using water only.

Ingnifugo/Fire Retardant

- EN 1021 1-2
- BS 5852 1-2

RIVESTIMENTI / COVERINGS

TESSUTO / FABRIC

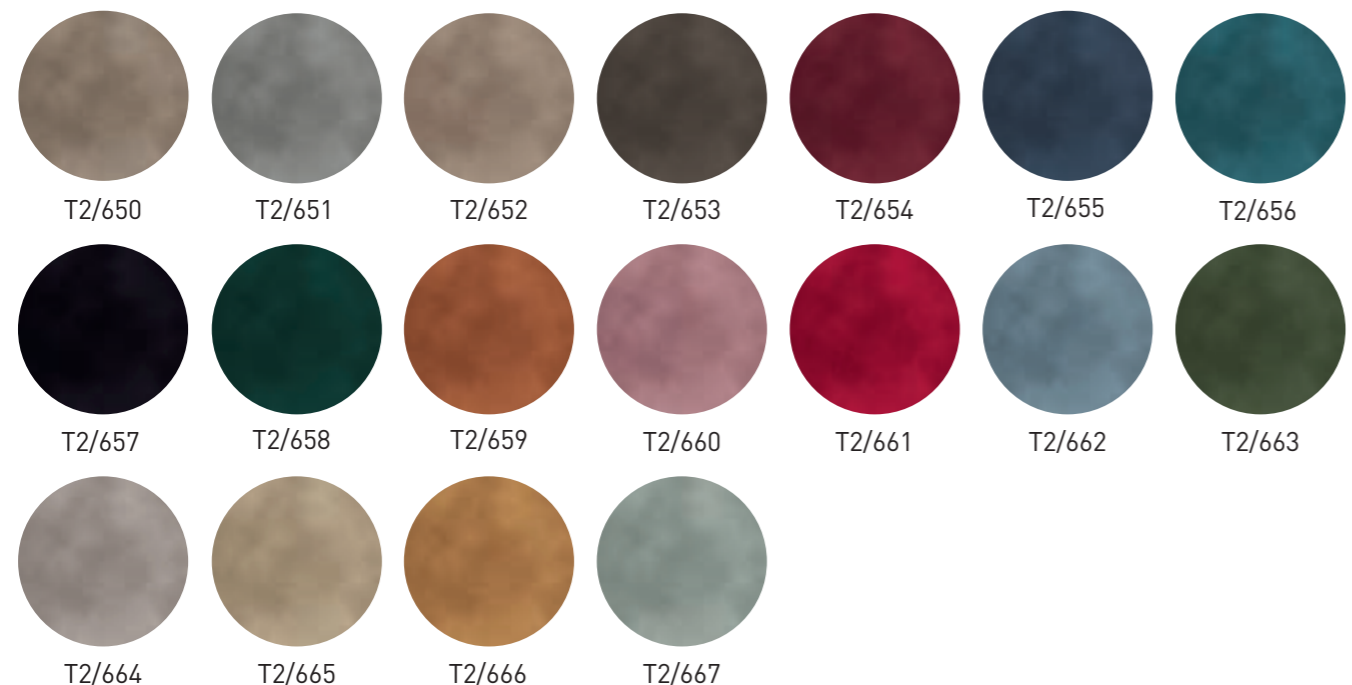

Ingnifugo solo su richiesta
 Fire Retardant on request only

TESSUTO / FABRIC

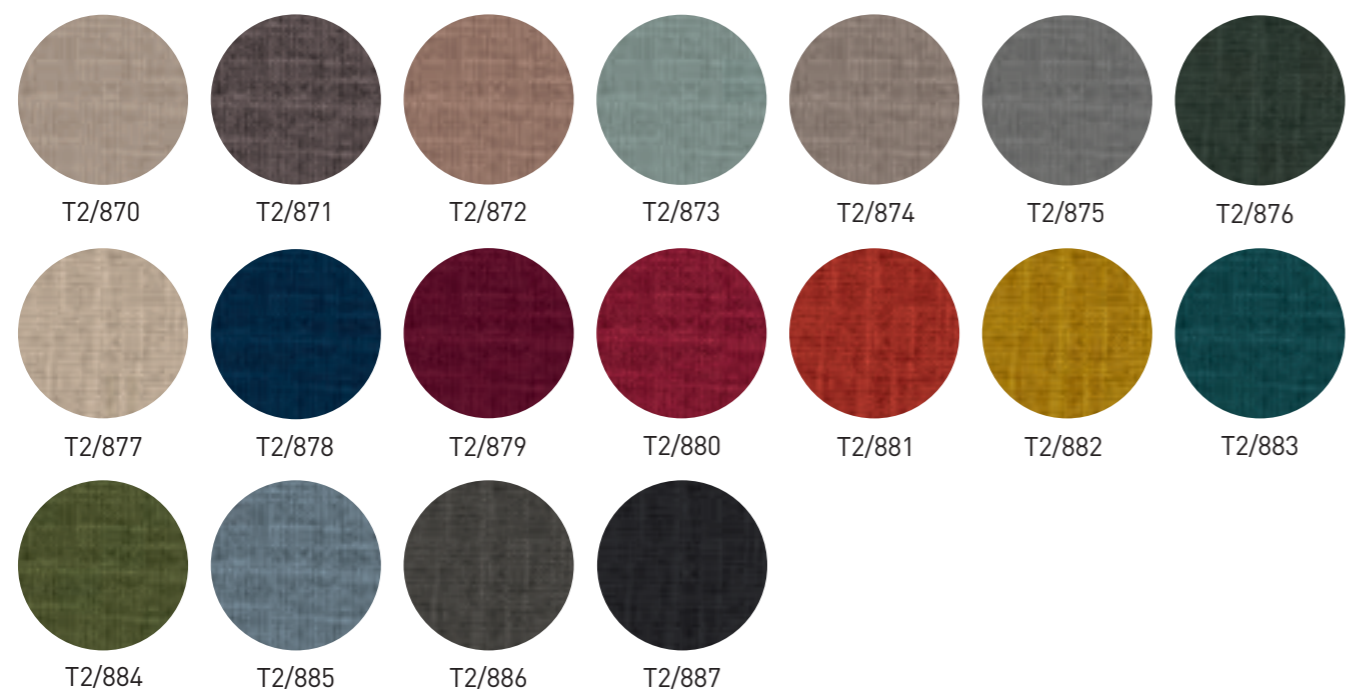

Scheda Tecnica / Technical details

Peso / Weight 465 g/m2
 Composizione / Composition 100% PL
 Abrasione / Abrasion (Martindale) > 80.000 cicli/cycles
 Evitare l'esposizione diretta ai raggi solari / Avoid exposing to direct sunlights

RIVESTIMENTI / COVERINGS

ECOPELLE / FAUX-LEATHER



Ingnifugo / Fire Retardant
 • Classe 1M (UNI9175)
 • CRIB 5 (BS-5852-1 PART1)
 • EN 1021-2
 • TB 117 SEZ.E. - P.1 (California)

NOTE TECNICHE / TECHNICAL DETAILS

MODELLI / DATI / MISURE

I dati e le misure riportate nel catalogo sono puramente indicativi e mai impegnativi.

L'azienda si riserva il diritto di apportare tutte le modifiche che riterrà opportune ai relativi modelli, compresa la soppressione di alcuni, senza alcun obbligo di preavviso.

MATERIE PLASTICHE

I policarbonati (PC) hanno un'alta resistenza al carico ed alla flessione ma hanno anche il problema di avere superfici tenere e facilmente graffiabili; tale peculiarità intrinseca nel materiale non può costituire motivo di reclamo. Il polipropilene è un materiale più opaco, più duro e ruvido ma meno soggetto a scalfirsi.

IMBOTTITURE

Tutti i prodotti che presentano delle imbottiture possono essere realizzati con rivestimento fornito dal cliente. In tal caso è necessario che il materiale sia idoneo alla lavorazione e che venga inviato in porto franco, accompagnato da un documento di trasporto e da una nota nella quale siano chiaramente indicati il nominativo del cliente, il numero d'ordine, il riferimento ed il verso di applicazione.

FINITURE LEGNO

La finitura del legno può essere realizzata su campione fornito dal cliente. A questo proposito è necessario informarsi preventivamente presso l'azienda per la fattibilità, e successivamente, inviare il campione indicando chiaramente sullo stesso il nome del cliente, il numero di ordine ed il riferimento. La finitura sarà realizzata il più simile possibile al campione, nei limiti delle caratteristiche tecniche del materiale, tenendo conto che sono sempre possibili lievi differenze tra i vari elementi che compongono il prodotto. Si precisa che in caso di prodotti acquistati in tempi diversi possono verificarsi variazioni di colore e/o di tonalità. Tutte queste differenze non possono costituire motivo di reclamo e/o di merce resa.

MODELS / SPECIFICATIONS / DIMENSIONS

The specifications and dimensions indicated in the catalogue are approximate and not binding.

The factory reserves the right to change its models as deemed necessary to cancel some products without prior notice.

PLASTIC MATERIALS

Polycarbonates have high resistance to load and pressure but have mild and easy scratching surface; this peculiarity of the material shall not give rise to claims. Polypropylene is matter, harder and rougher but less easy to engrave.

PADDING

All products with upholstered parts can be made in customer own material (COM). In this case the material has to be suitable to be processed. The customer has to send it to the factory free of charge together with a slip showing the name of the customer, the number of order, the reference and the side of application.

WOOD FINISHES

The wood finish can be made according to customer's reference. In this case information should be ask to the factory about it, at first. Afterwards the sample has to be sent with customer's name, number of the order and reference name written on it. The finish will be made as far as closer to the sample, taking into consideration the technical properties of the materials. Slight color differences of the element that make up the products are always possible. In case of products purchased in different times, changes in color and/or shades are likely. All these differences shall not give rise to claim.

XLINE

by Sedex srl

Loc. Fosci 25/b 53036 Poggibonsi (SI) Italia

tel +39 0577 988021 fax +39 0577 988118

email info@x-line.it www.x-line.it